

# OMNIMARK



INSTRUMENT CORPORATION

# $\mu$ Wave

## **Microwave Moisture Analyzer**

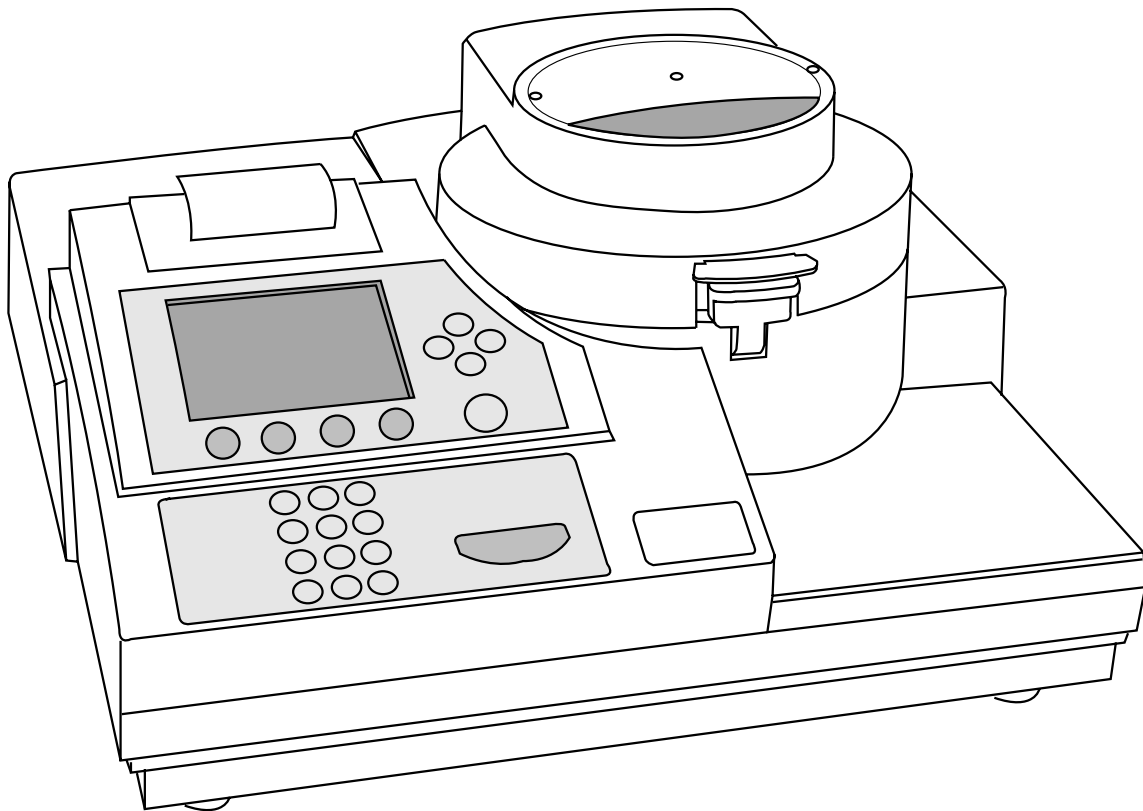

## Operating Instructions

901812.1 Rev. C.

You have purchased a quality precision instrument that requires handling with care.

*Read entire contents of this **Operation Manual** prior to operating your new Omnimark  $\mu$ Wave Moisture Analyzer.*

Class A Digital Devices:

**Notice:** This equipment has been tested and found to comply with the limits for a Class A digital device, pursuant to Part 15 of the FCC rules. These limits are designed to provide reasonable protection against harmful interference when the equipment is operated in a commercial environment. The equipment generates, uses, and can radiate radio frequency energy and, if not installed and used in accordance with the instruction manual, may cause harmful interference to radio communications. Operation of this device in a residential area is likely to cause harmful interference in which the user will be required to correct the interference at his own expense.

**Caution:** Changes or modifications not expressly approved by the manufacturer could void the user's authority to operate this equipment.

Manufactured in the U.S.A. by:

 **Denver Instrument Company**

---

6542 Fig Street • Arvada, Colorado 80004 U.S.A.  
1-800-321-1135 • (303) 431-7255 • Fax (303) 423-4831

*This manual covers Software Version 3.73 and greater.*

# Table Of Contents

---

Introduction	1
Warnings and Safety Precautions	1
Equipment Installation	3
Selecting Location	3
Unpacking	3
Installing Sample Support	3
Connecting to a Power Source	3
Connectors	4
Controls	5
Display Screen	5
Keypad	5
Technical Specifications	7
Testing	7
Main Screen	10
Select Procedure	10
Select Operator	10
Data Log Menu	10
Setup Menu	11
Develop/Modify Procedures	11
Modifying Operators	14
Calibrate Balance	14
Results Printout Format	15
Time Date Format	15
Audio/Video Menu	16
Serial Port Menu	16
Security Menu	17
Service Menu	17
Applications	18
Appendix A Recommended Care	20
Appendix B Printer Paper Installation	20
Appendix C Maintenance	21
Appendix D Troubleshooting	21
Appendix E Serial Communication Commands	22
Appendix F Accessories	23
Appendix G Factory Default Drying Procedures	23
Warranty Statement	Inside Back Cover

## Cautions and Warnings



**Warning!** - Prior to attempting to operate, read all accompanying documents.



**Risk of Shock!** - Due to the electrical nature of this instrument, do not attempt to disassemble unit. Contact Omnimark Instrument Corporation Technical Support with any problems that arise.



**High Temperature Parts** - During operation use caution around exhaust areas of the instrument.

# Introduction

---

Thank you for choosing the Omnimark Instrument Corporation ***μWave*** Moisture Analyzer. The ***μWave*** is a rapid moisture determination system using the principle of loss-on-drying with microwave energy heating. Samples, generally greater than 10% moisture, are radiated with microwave energy in the patented cylindrical induction applicator while monitoring the microwave absorption and the use of an integral precision electronic balance. When endpoint conditions are met the final weight is compared to the initial sample weight to calculate percent moisture or solids. The ***μWave*** is uniquely designed to combine the performance and sophistication of modern laboratory instrumentation, however in a rugged and simplistic analyzer intended for plant floor usage.

The ***μWave*** is not designed with the intention of being a general-purpose moisture analyzer. However, it specializes in high moisture (generally greater than 10%) samples. Caution must be given to the sample type, composition, and level of moisture to prevent damage to the analyzer or personal injury. Carefully read the Warning and Safety Precautions section of this manual and contact Omnimark Instrument Corporation if there are any questions on the applicability of the ***μWave*** for your samples.

After unpacking your ***μWave***, it is recommended that the user first read the Operating Instructions in its entirety. Special attention must be paid to the Warning and Safety Precautions section, Equipment Installation section, and the Operations section. In addition, an Applications section is included to assist the user in developing their own drying procedures.

## Warnings and Safety Precautions

---

### Precautions to avoid excessive microwave energy:

Do not attempt to operate this microwave oven with hood open since open-hood operation can result in harmful exposure to microwave energy. It is important not to defeat or tamper with the safety interlocks.

Do not place any object between the upper and lower portions of the chamber or allow a buildup of sample material to accumulate on the sealing surfaces.

Do not operate the analyzer if it is damaged. It is particularly important that the chamber hood closes properly and that there is no damage to the hood, hinge and spring or sealing surface.

The analyzer should not be adjusted or repaired by anyone other than Omnimark Instrument Corporation or authorized repair personnel.

- For the safety of the operator and analyzer, this unit will not operate under 90% of necessary voltage. If the analyzer does not function, be sure to check the line voltage into the instrument.
- It is not recommended to operate above 3000 M altitude.
- Do not store or attempt to operate below -25°C.



**Warning:**

Use of this product in a manner not specified by the manufacturer, may impair any safety protection provided by the equipment!

Every attempt has been made to make this analyzer safe and easy to use. However, like any laboratory instrument, respect must be given to the operation of the analyzer due to environmental conditions, the nature of samples being tested and other chemicals that might be near the analyzer. To avoid personal injury, exposure to excessive microwave energy or damage to the analyzer, please observe the following precautions:

- Read all instructions prior to operating your moisture analyzer.
- This analyzer must be electrically grounded. Connect it only to a properly grounded outlet as described on page 4.
- See hood surface cleaning instructions in the recommended care section, page 20.
- Locate this analyzer only in accordance with the installation instructions on page.
- Always use tweezers or tongs to remove the sample upon completion of a test because the sample may be hot.
- Use appropriate sample handling techniques to prevent spillage into the chamber or other areas of the instrument (i.e., use pipettes, droppers, etc. for sample addition onto the pads). Do not pour sample into the chamber directly from containers. If an incident of excessive spillage does occur, allow 24 hours to dry internally before powering the instrument back up.
- Do not test flammable, explosive, metal or toxic material.
- Know where the fire extinguisher is located. Use only an extinguisher rated for use on electrical fires.
- Keep the instrument clean.
- Wear safety glasses, protective clothing and gloves.
- Keep warning labels clean and preserve their warnings at all times.
- Do not block the ventilation inlets and outlets and the sides and back of the analyzer.
- If necessary, press any key during a test to abort the test. The analyzer will return to the Main Screen.
- Locate the unit away from flammable materials.

**Safety Design Features**

Product design efforts have been focused on maximizing safety, for the protection not only of the operator, but for the product itself.

# Equipment Installation

---

## Selecting the location

Select a suitable work area that will allow your analyzer to work with accuracy and dependability:

- This product is intended for indoor use only.
- Relatively free from drafts and vibration.
- Surface should be rigid and level.
- Allow adequate ventilation (at least one inch of free space around all four sides of the analyzer).
- Do not locate near magnetic materials, or near equipment or instruments which incorporate magnets in their design.
- Avoid areas that have variations in room temperature or have excessive room temperatures. Room temperatures above 40°C/104°F or below 15°C/59°F could affect the operation and accuracy of your analyzer.

## Unpacking

The **μWave** is packaged in one container box. Care should be taken in handling and lifting the **μWave** due to its heavy weight (approximately 70 lbs). Open the box from the top and remove the accessory kit. Then carefully lift the **μWave** to the desired location.

Content of packaging:

- Analyzer
- Operating Instructions manual
- Sample support (including stem, basket and pin)
- Power Cord
- Disposable sample pads (1 box)
- Extra roll of paper
- Calibration Weight
- Warranty Card
- Certificate of Calibration

Keep all parts of the packaging in a safe place. This packaging guarantees the best possible protection for the transport of your analyzer.

Except as noted in this manual, this analyzer contains no user serviceable parts. Do not disassemble the unit. Unauthorized repair attempts may void the warranty. For service, call Omnimark Instrument Corporation or your local distributor.

## Install Sample Support

To install the sample support in the drying chamber:

1. Lift the hood using the handle.
2. Remove the balance constraint device.
3. Slip either end of the stem of the sample support into the mating receptacle (beyond the bottom of chamber) and align.
4. Confirm that the sample basket, which holds the sample during testing, is level.

## Connecting to a Power Source

The analyzer is delivered in either a 100V, 50/60Hz model, a 120V, 60Hz model or a 230V, 50Hz model. All versions are 550W of which 450W are delivered to the drying chamber. Check that the unit, which you have received, is the correct voltage for your local line voltage. If the voltage is not correct, DO NOT attempt to connect it to the line voltage; but contact Omnimark Instrument Corporation or your local distributor immediately.

1. First insert the appropriate power cord into the power input on the rear panel of the analyzer.
2. Plug the power cord into a convenient grounded wall outlet.
3. To turn the analyzer ON, place the ON/OFF switch on the back of the analyzer into the ON position. The analyzer will proceed through a self-diagnostics routine, print unit information, and then display the main screen. If the analyzer displays any diagnostic warnings, consult the troubleshooting section of this manual and call Omnimark Instrument Corporation or your local distributor.



### Warning!

This analyzer must be electrically grounded. Connect it only to a properly grounded outlet. For maximum safety, this and all grounded chassis electrical appliances should be operated from a correctly polarized and properly grounded outlet.

Do not, under any circumstances, cut or remove the grounding prong from the supplied power cord.

**Extension cords should not be used.**

### Connectors

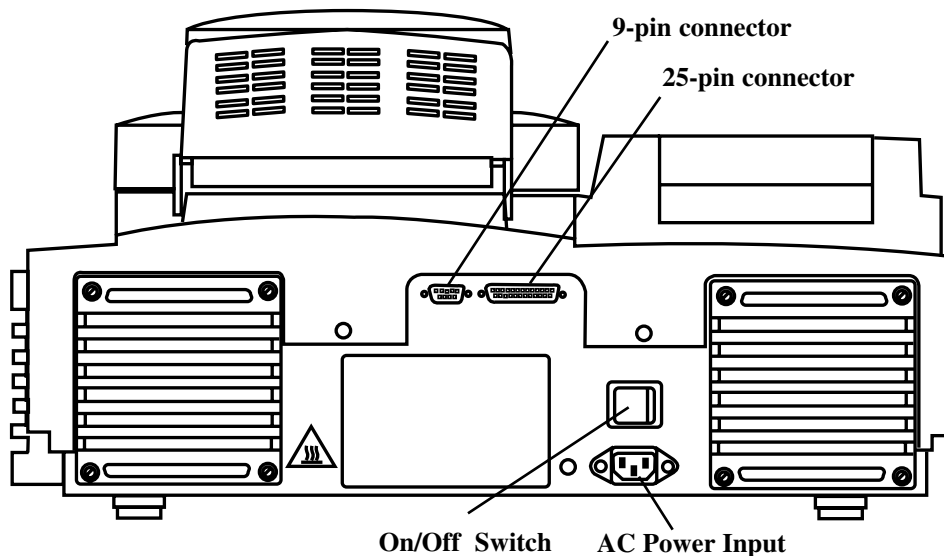

**Power** - Accepts the universal female end of the appropriate power cord.

**25 pin connector** - This output port supports a bi-directional RS232 interface via a 25 pin, DB-25P type connector. Use for intercommunication between two moisture analyzers for the purpose of transferring drying procedures through the "transmit all procedure" subroutine, send results to a computer or printer, or command the instrument through computer or similar device.

**9 pin connector** - This output port supports a uni-directional RS232 interface via a 9 pin, DE-9S type connector. Any RS232 compatible device such as an external printer or computer can be connected to the analyzer to receive (only) data output.



# Controls

---

The following paragraphs briefly describe the location and functions of all the analyzer controls. More detailed descriptions are provided in the following sections of this manual.

## Display Screens

The analyzer features a 3.6" x 4.8", VGA resolution back lit liquid crystal display (LCD). This large, dot addressable LCD allows the analyzer to convey a rich variety of detailed information with descriptive prompts, menus and help messages. There are four different types of screens that will be displayed: MAIN, START, SETUP and related screens. A title line on the top of every screen identifies the specific screen displayed along with the date and time.

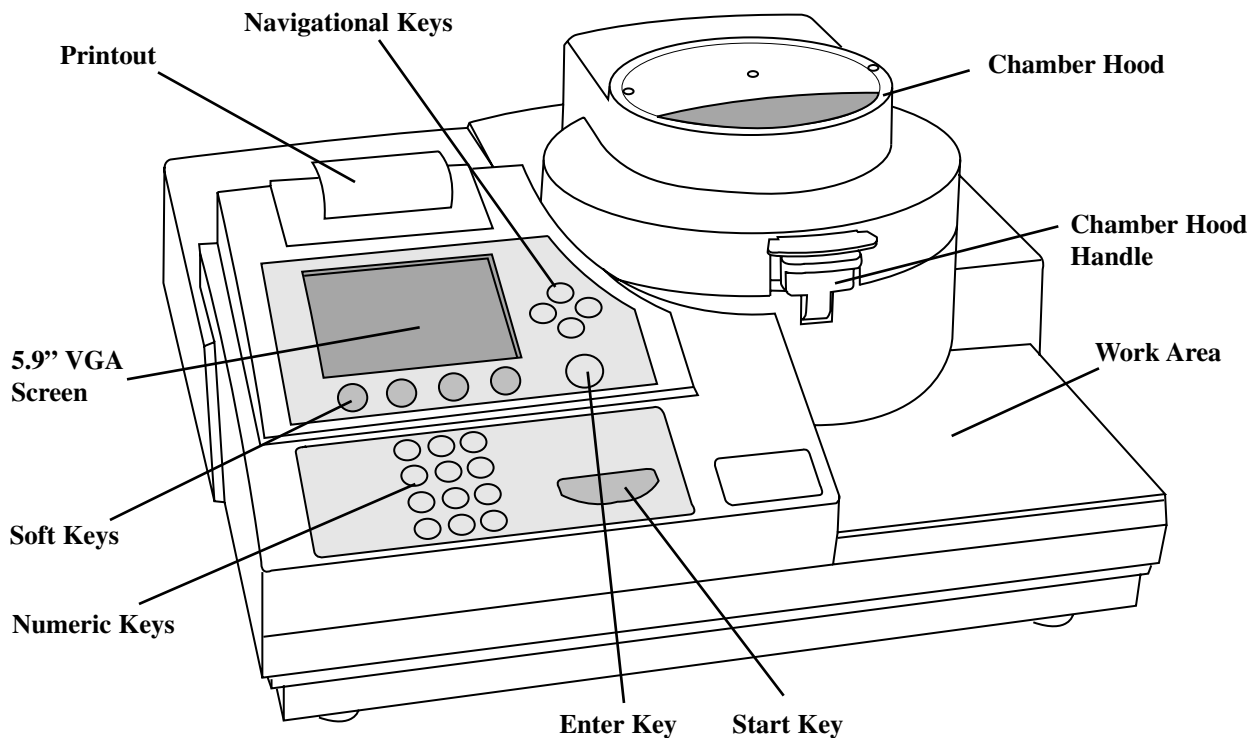

**START** – This set of screens prompt the operator through testing a sample including zeroing the balance, adding sample, measuring initial weight, testing and printing the result.

**MAIN** – This screen will be displayed when the instrument is turned on or when pressing the icon softkey. The Main Screen provides access to the Procedure, Operator, Data Log and Setup Menus.

**SETUP** – The Setup screen provides menu options of all the available setup sub-routines for customizing the analyzer.

## Keypad



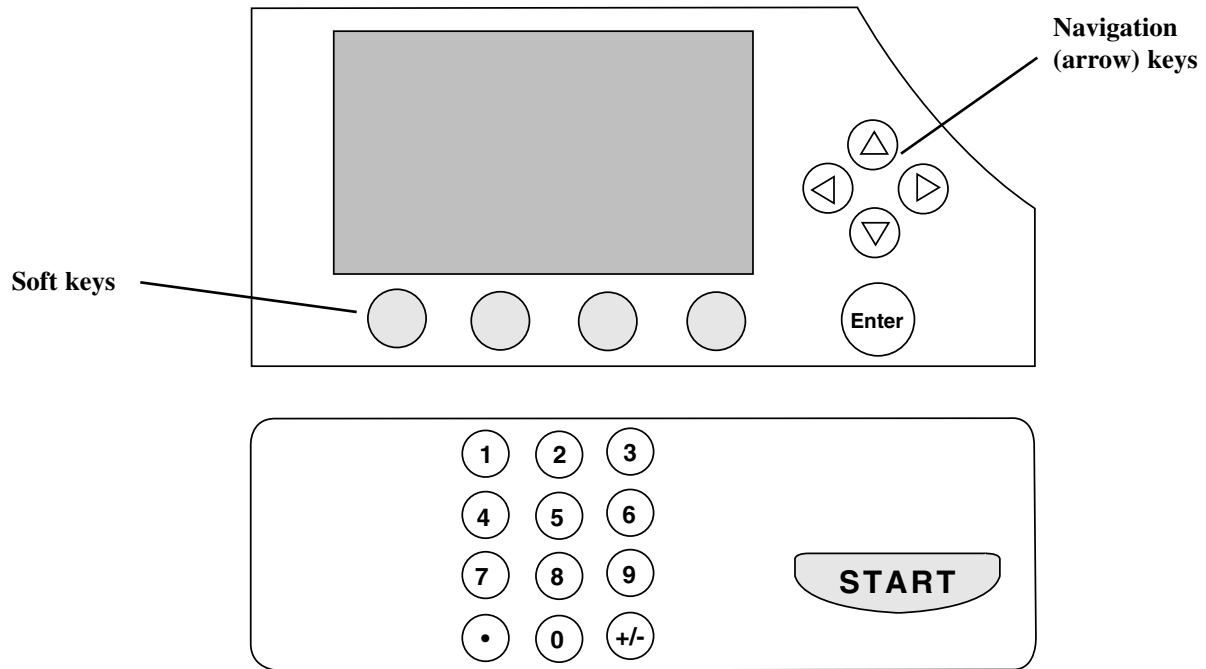

The analyzer features a membrane keypad with numeric, navigation (arrows), soft and function keys as shown in the figure above. The keypad is best operated with a firm button press in the center of the key. With the keypress beeper turned on, an audible tone will sound whenever a key has been pressed correctly.



**Function keys include the following:**

- Start - This key initiates the test cycle to begin analyzing a sample from any screen.
- Enter - This key prompts the analyzer to accept entry of data keyed in by the user or accepts any highlighted choices on the display.
- Navigation (arrow) keys - scroll to highlight the desired selection as well as through alphanumeric entries.
- Softkeys - located directly below the display. The label on the display will change depending on the software routine.

**Softkeys include, but are not limited to, the following:**

-  Help - Help offers the user immediate, context-specific advice on setup and operation.
-  Return - Returns the user to the Main Screen from any other screen.
-  Print - Prints the current screen.
-  Back - Returns the user back one menu. Also used to clear values when typing in values.
-  Blank - No Function

## Technical Specifications

---

Measurement method	Microwave radiation and detection of weight loss
Power setting	30-100% of 450 watts
Balance capacity	30 grams
Balance readability	0.1 mg
Readability of result	0.01%
Working range	10-100% Moisture
Units of results	Percent moisture, solids, volatiles, mg/L, weight loss and custom
End of analysis modes	Time-out or custom slope with sensor
Display	5.9" VGA resolution backlit liquid crystal display (LCD) (320 X 240 dots)
Controls	Start, Enter, 4 arrows, 4 softkeys and numeric keypad with decimal and +/- keys
Program storage	30 drying procedures with alphanumeric naming
Data storage	495 last results with statistical evaluation
Integral printer	Thermal, graphical 500 dots per line
External I/O	One serial bi-directional and one serial uni-directional RS232
Input power requirements	100V, 50/60 Hz, 550W, 10 Amps 120V, 60 Hz, 550W, 10 Amps 230V, 50 Hz, 550W, 5 Amps Class I Equipment (grounded) Mains supply voltage should not exceed +10% of the nominal supply voltage
Sound Pressure	<70 dBA
Operating Temp Range	15°C - 40°C
Recommended Altitude	<3000 M
Operating Humidity	80% for temperatures to 31°C, decreasing linearly to 50% relative humidity at 40°C
Pollution Degree	2
Installation Category	II for transient voltages
Indoor Use Only	

## Testing

---

Analyzing a sample on the **µWave** is intended to be simple and rapid. However, to take full advantage of the performance and versatility of the analyzer, the drying procedure should be optimized for the sample being tested. For helpful hints on how to establish an optimized drying procedure, see the Applications section of this manual, contact Omnimark Instrument Corporation or your local distributor. To setup the analyzer to your specific requirements, refer to the Setup section of this manual.

Most samples can be tested for percent moisture using the Default Procedure with reasonable results and safe drying conditions. However, if your distributor has tested your samples and has developed an optimized drying procedure, you will first want to enter a new program, with these settings, as described in the Setup section of this manual.

**To test a sample, perform the following:**

1. Press the Start key to initiate a test cycle from any screen.
2. (If sample number or batch ID prompts are on these will need to be entered.) The instrument will then prompt you to add the test pad(s).
3. Open the hood using the handle on the front of the heating chamber and place one or two sample pads onto the sample support. Then close the chamber hood. (Pads will be pre-dried if this feature is on.)
4. The instrument will zero the balance to eliminate the sample pad(s) weight from the overall weight reading.

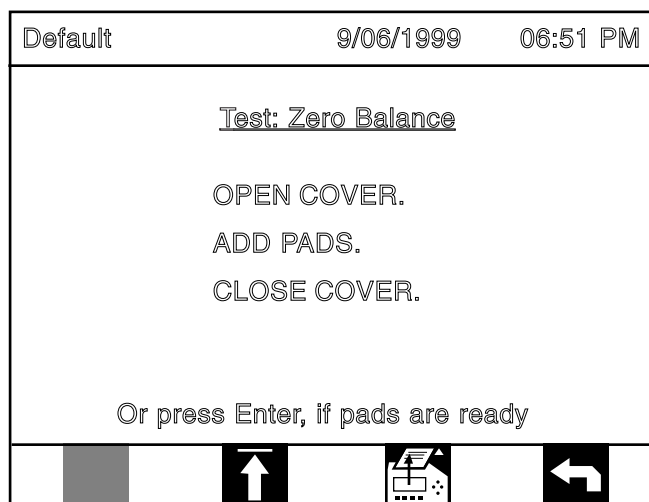

**Test: Zero Balance Screen**

5. At the prompt, open the hood and add the sample to the sample pad(s). The screen will display the sample weight in grams. If more convenient, the sample pad(s) may be removed for easier sample addition and spreading.



A bar graph will display the amount of weight added to the balance and its proximity to the pre-set desired weight. If the target weight beep is on the unit will beep as soon as the weight is within these parameters. To change the optimal weight settings refer to the setup section of this manual.

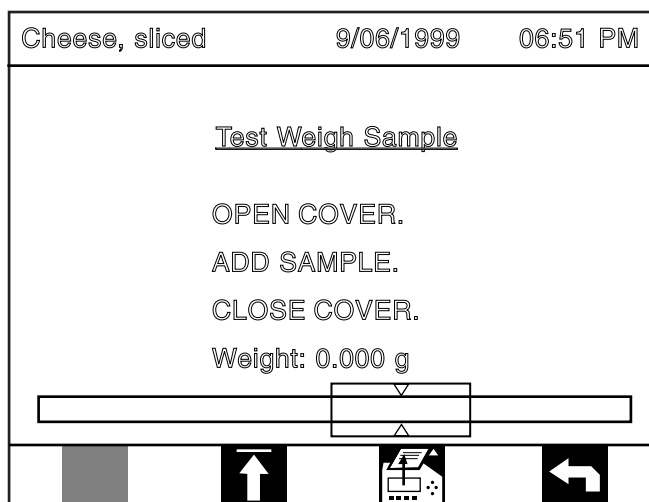

**Test: Weigh Sample**

6. After the desired amount of sample as been added, with the sample pads centered on the sample support, close the chamber lid securely.
7. When the displayed weight in grams has equilibrated the ***μWave*** will automatically take the sample weight. (If sample prep mode is on the instrument will allow for the sample to be removed from the chamber.)
8. The test will then begin and the Start Screen will indicate that the test has begun.



***Test in Progress Screen***

9. The analyzer will proceed in determining the moisture content of the sample using the recalled drying procedure. When the endpoint condition is met, the test will automatically stop and the result will be printed. At the end of the test, the display will prompt you to return to the main menu or run another test.

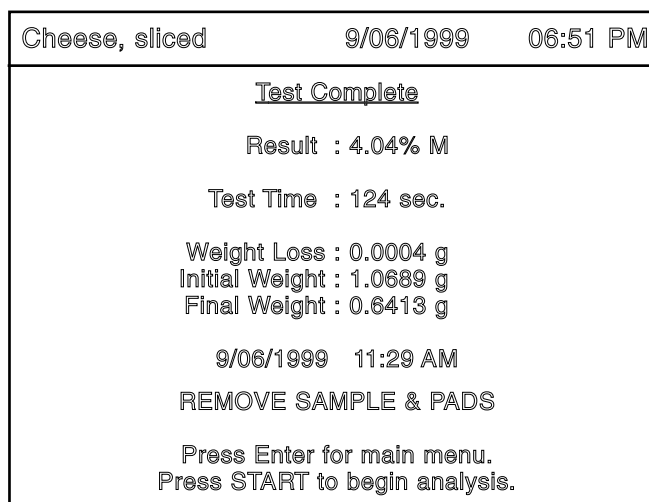

***Final Result Screen***



To stop the test for any reason during analysis, press any key.

10. Raise the hood and carefully remove the sample prior to another test.

# Main Screen

---

## Select Procedure

This routine numerically lists the programs (up to 90) that have been saved within the unit for recall. First, select the set the program was stored in (1-30, 31-60, 61-90) Then use the navigational arrows to highlight the pre-set program and press "Enter". The next test ran will use the parameters of the procedure selected. See setup section to add or modify procedures.

## Select Operator

Much like the select procedure menu this routine allows selection of the current operator. Using the navigational arrows, highlight the pre-set operator's name and press enter. This information will be printed with each result so that a catalog of who ran the test may be maintained. Up to 11 names can be saved for recall. See setup section to add or change names.

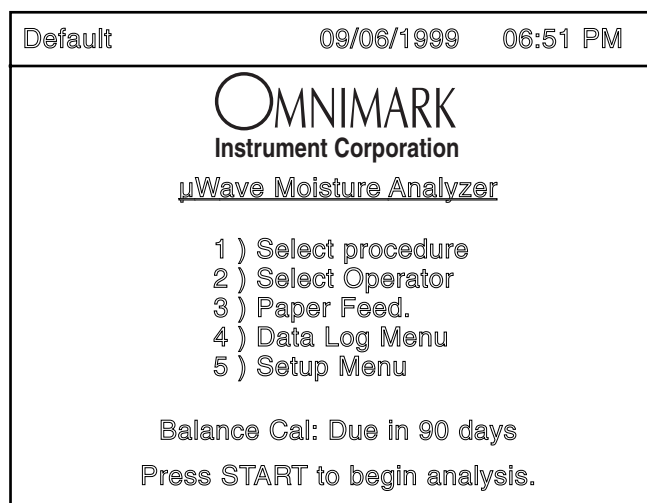

**Main Screen**

## Paper Feed

Feeds the paper through the printer.

## Data Log Menu

This allows the user to view and print collected data.

- 1) Print last test:** This will print the data from the last test performed using the guidelines set in the result printout menu.
- 2) View data log:** This provides a list of data gathered by the moisture analyzer. It will display program name, time and date ran, analysis time and final result.
- 3) Print data log:** This will export all information held in the data log to the printer. Again printing the program name, time and date ran, analysis time and final result.
- 4) Print statistics:** Exports statistical data for results in the data log for each of the procedures to the printer. Includes procedure name, number of test the statistics are based on, average, standard deviation, relative standard deviation, minimum result, and maximum result.
- 5) Set maximum count:** This is the maximum number of results to be used in the calculation of statistics. Entering 0 will calculate statistics on all results in the data log.

- 6) **Set data range start:** Defines the starting point for the data log begins. The current start date is displayed in the lower portion of the screen on the left side.
- 7) **Set data range end:** Defines the ending point for when the data log stops storing data. The current end date is displayed in the lower portion of the screen on the right side.
- 8) **Select data points:** : Allows the user to select individual points for statistical calculation. Using the navigation keys, highlight the first result statistics are to be performed on. Press "Enter" and the word "STAT" will appear along with the result. Continue to select all points, in this manner, for statistical calculation. to remove a point from statistical calculation, press "Enter" again and the word "STAT" will disappear. When finished, press the back softkey to return to the Data Log Menu

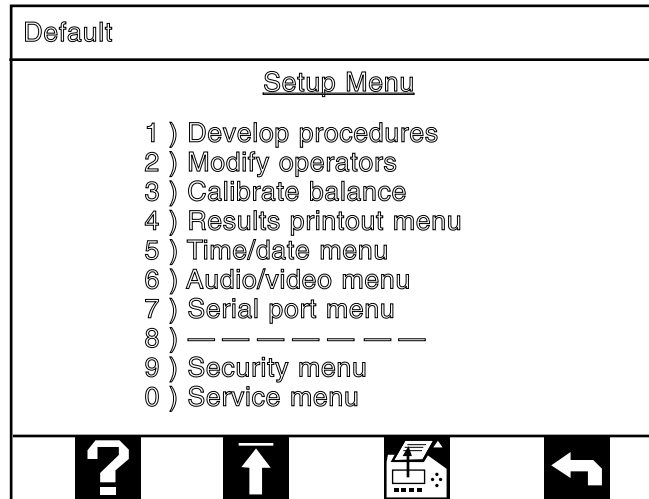

**Setup Screen**

## Setup Menu

---

### **DEVELOP PROCEDURE**

In this menu the user can develop, modify, or delete a procedure.

- 1) **Develop new procedure:** In this menu the operator can fully develop a drying procedure by selecting various settings. The ***μWave*** will automatically bring up the first available open slot for the new procedure. If all 30 slots are

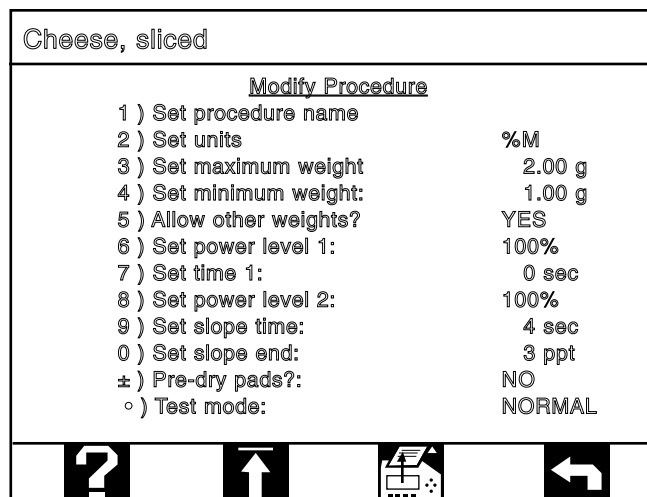

**Modify Procedure Screen**

in use the analyzer will prompt the user to delete one of the pre-existing procedures. To change any of the settings below, press the number key that matches the number of the selection on the display, or use the navigation keys to highlight the selection and press enter. After changes have been made press "Enter" to move back to the left side of display. Changes will be saved automatically when you press the "Start" key to begin a test or any of the softkeys.

- **Set procedure name:** Define an alphanumeric name for the procedure being developed. Using the navigational arrows move the cursor to the letter of choice and press enter. Press the numeric keys to add a number. To delete the last letter entered, use the back softkey. When finished, highlight "Save and Exit" and press enter.
- **Select units:** In this subroutine the operator can select the units for which the instrument will calculate and display the results from each test run.

%M	Moisture	Initial Wt-Final Wt/Initial Wt x 100
%S	Solids	Final Wt/Initial Wt x 100
%V	Volatiles	Initial Wt-Final Wt/Initial Wt x 100
mg	Weight	Initial and Final Weights
mg/L	Weight loss by volume	Use for filtered samples
xM	Custom Moisture	(%M x Factor) + Offset
xS	Custom Solids	(%S x Factor) + Offset

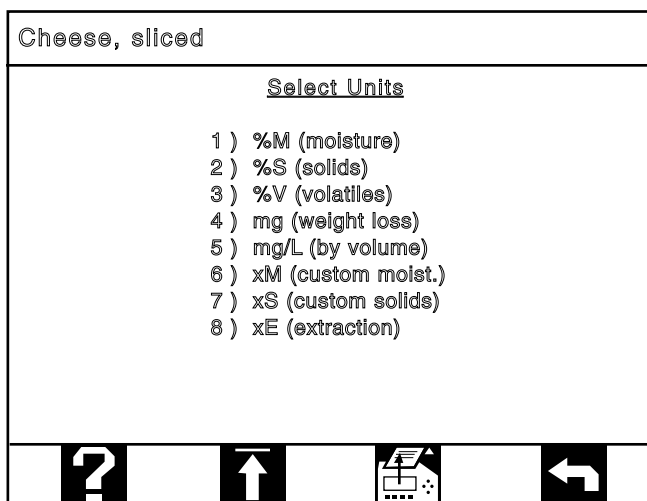

**Select Units Screen**

It may be necessary to set a bias for the procedure (xM or xS units). See the custom unit section in the application section for more information on this setting.

- **Set maximum weight:** This is the upper end of the desired sample size. During testing, the bar graph window and target weight beep will end at this value. This value can be set to meet desired testing requirements. It is recommended that the limits be set at 110% of a targeted sample weight.
- **Set minimum weight:** This is the lower end of the desired sample size. During testing, the bar graph window and target weight beep will start at this value. This value can be set to meet desired testing requirements. It is recommended that the limits be set at 90% of a target sample weight.
- **Allow other weights?:** If 'NO' has been selected then the **μWave** will not begin a test if the sample weight falls outside the minimum and maximum weight as defined above.



- **Set power level 1:** This setting is crucial to the drying procedure as it defines the amount of pulsing done by the magnetron as it sends microwaves into the drying chamber. The range of this setting is 30-100% in 10% increments. For more detailed information on power level setting for optimizing a drying procedure see the applications section.
  - **Set time 1:** Used mainly in the two-step drying process when the instrument needs to switch from power level 1 to power level 2. It is also useful if the sample needs an amount of time (set as time 1) before it begins to release its moisture. If you do not want a minimum time hold, set time 1 to 0. Typically time 1 does not exceed 150 seconds.
  - **Set power level 2:** Also used in a two-step drying procedure with a range of 30 – 100%. This is the power setting that the analyzer needs to switch to after time 1 has expired. Unlike power level 1 this setting may not be timed out, it refers to the slope values in order to determine the stopping point of the analysis. This value will be ignored in testing if time 1 is set at "0".
  - **Set slope time:** This is the first of two settings to determine the end point for a sample. As the amount of water in the sample decreases, so does the absorption of microwaves by that sample. Throughout the test the unit continuously looks back at the sensor reading of absorbed microwaves. The amount of time the unit checks for change in absorption is dependent on the setting of the slope time, with units of seconds. If the slope time is increased (max is 25 seconds) then the unit looks over a longer period of time at the absorption by the sample. Likewise if the slope time is decreased (min is 2 sec) then the time frame that the unit looks at is decreased.
  - **Set slope end:** This is the second factor in determining the endpoint for the analysis. In order for the test to be completed, the change in absorption (in parts per thousand) must be less than the value of the slope end over the time defined in the slope time. The smaller the slope end (min is 0 ppt, max is 20 ppt) the less absorption may be detected which means less moisture is detected.
  - **Pre-dry pads?:** It is very important that the sample pads are dry before adding sample. In high humidity environments or for applications where low moisture levels in pads may create a problem, turn this feature on. After the pads have been placed in chamber for zeroing the balance, they will be dried for 15 seconds and then the balance will be zeroed.
  - **Start Mode:** Press this key to toggle between "Normal", "+Water" and "Prep" modes. Normal mode is the most common however some applications need further sample preparation or water addition. When the "+Water" or "Prep" mode is activated, the  **$\mu$ Wave** will pause after the initial weight has been taken and allow for water addition or the sample to be removed. When the hood is closed the test will begin automatically.
- 2) **Modify procedure:** This allows the user to examine and modify any procedure that has been saved. Use the navigation arrows to highlight the program to be modified and then press "Enter". The current settings will be displayed, changes are made by following steps in the above procedure under developing a program. Changes will be saved automatically when you press the "Start" key to begin a test or any of the softkeys.
  - 3) **Delete procedure:** This subroutine deletes any saved program from memory. Using the navigation keys, highlight the program to be deleted. Press "Enter". After selecting a procedure for deletion the screen will prompt for confirmation.
  - 4) **Print all procedures:** Prints the procedure name, units, target weight, power, time, slope parameters and mode of all procedures stored in memory.

- 5) **Print current procedure:** Prints the procedure name, units, target weight, power, time, slope parameters and mode of currently selected procedure.
- 6) **Alphabetize procedures:** Puts the procedures in alphabetical order for easy recall.
- 7) **Setup menu:** Returns to the setup menu.

### **MODIFY OPERATORS**

Much like the procedure menu, this allows the modification and deletion of operator names.

- 1) **Set operator name:** This option will display the saved operator names. To add a new name, press the number next to a blank space or highlight a blank space and press "Enter". If all available spaces are full, the user must first delete one of the names (see next section). Move the cursor to the first letter of the name and press "Enter". When done, use the navigation keys to highlight "Save & Exit" and press "Enter". To modify a name, press the number next to a blank space or highlight a blank space and press "Enter". The back soft-key will delete the letters started at the end of the name. When done, use the navigation keys to highlight "Save & Exit" and press "Enter".
- 2) **Delete operator:** Here the user will be able to delete any or all of the previously saved operator names. Simply press the number next to the operator to be

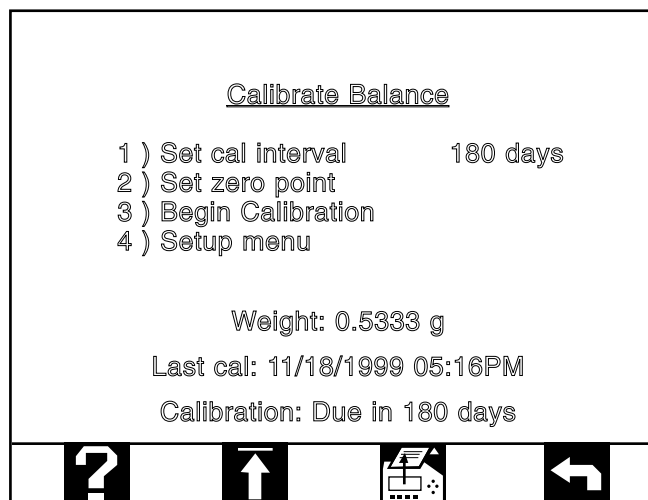

***Calibrate Balance Screen***

deleted. The operator will be deleted and the *μWave* will go back to the modify operators menu.

- 3) **Print all operators:** Prints all operators currently stored in memory.
- 4) **Setup Menu:** Saves all changes and return to the Setup Menu.

### **CALIBRATE BALANCE**

The calibrate subroutine allows periodic calibration of the balance. Calibration should be performed when ever the analyzer is moved or a large temperature change occurs. You will need a 2, 5, 10, or 20 gram weight to calibrate the analyzer. At the bottom of the screen the last calibration date will be displayed as well as the number of days before the next calibration is due.

- 1) **Set cal interval:** This subroutine allows the user to set the amount of time between calibrations. When the calibration time has expired a 'cal' icon will appear on the main screen.
- 2) **Set Zero Point:** This simply tares the balance, setting the unit to zero grams.
- 3) **Begin calibration:** This will prompt the user through the calibration procedure using the a 2, 5, 10, or 20 gram weight. First, open the hood and remove samples and pads. Next, close the hood and wait while the unit automatically tares the balance to zero grams. At the prompt, open the hood and place a one of the weights on the sample support and close the hood. The balance will recognize the weight and calibrate the balance. If calibration was successful the unit will display a prompt to remove the weight and press "Enter" to return to the calibration menu. If calibration is unsuccessful, call Omnimark Instrument Corporation or your local distributor for technical assistance.

### RESULTS PRINTOUT MENU

The menu allows the user to fully customize the amount and type of information that is printed following each ***μWave*** test run.

- 1-3) **Set print line:** Use to personalize the printout header alphabetically and numerically. The current message is displayed under line 3. Press the number of the line you would like to change. Using the navigational arrows move the cursor to the letter of choice and press enter. Press the numeric keys to add a number. To delete the last letter entered, use the Back softkey. When finished, highlight "Save and Exit" and press enter.
- 4) **Turn analyzer info on/off:** When this is turned on the software version and serial number of ***μWave*** will print.
- 5) **Turn procedure name on/off:** When this is turned on the procedure name will be printed.
- 6) **Turn operator name on/off:** When this is turned on the operator may be selected and printed.
- 7) **Turn sample number on/off:** Allows the user to input a sample # (as selected below as prefill sample number) for each analysis before the test begins.
- 8) **Turn weights on/off:** When this is turned on the weight loss, initial weight, and final weight will be printed.
- 9) **Prefill sample number:** Used to determine select the type of sample number for each test. Press #9, or "Enter" when this selection is highlighted, to select the desired setting. The "incr" mode increases the number by 1 for the next test, useful for continuous testing. The 'last' option displays the same sample number as the last test, useful for multiple runs of the same sample. When "none" is selected the sample number will be blank. The "scan" option allows input of scanned alphanumeric bar code.
- 0) **Turn batch label on/off:** This is an alphanumeric label that is useful when several samples from same batch are to be tested. When it is turned on and a test is started, it will allow the user to enter a name. Using the navigational arrows move the cursor to the letter of choice and press enter. Press the numeric keys to add a number. To delete the last letter entered, use the Return softkey. When finished, highlight "Save and Exit" and press enter.
- ±) **Setup Menu:** Saves changes and returns to the setup menu.

```

12/03/1998 02:15 PM
Omnimark Instrument Corporation
μwave Moisture Analyzer
(808) 835-3211
Version 1.0.1203
Serial No. 00000
Cheese, Sliced
Operator: Alan
Sample: 1
50.43 %M
Test time: 33 sec
Weight loss: 0.5365 g
Initial weight: 1.0638 g
Final weight: 0.5273 g

```

## TIME/DATE MENU

In this subroutine the user can manually change the time and date as well as how they are displayed.

- 1) **Set time:** When setting the time, the 24 hour format must be entered as hour:min:sec.
- 2) **Set date:** The date must be entered in the same format as the date format selected by the user below.
- 3) **Time format:** Two time formats are available to the user, 24 hour or 12 hour with AM/PM.
- 4) **Date format:** Three options are available for setting the method in which date is displayed, month first, day first, or year first. This 8-character format is designed to recognize leap years.



**Note** Be sure to first enter a zero on months or days that are only single digits.

## AUDIO/VIDEO MENU

In this options menu the user can change the beeps on or off, as well as toggle the video contrast and color scheme.

- 1) **Keypress beep on/off:** When on, the *μWave* beeps when a key is pressed correctly.
- 2) **Target weight beep on/off:** When on, the *μWave* will sound when the weight of sample being added falls within the pre-set limits in the develop procedure section.
- 3) **End-of-test beep on/off:** A beep will alert the user when the test has been completed.
- 4) **Select video contrast:** Allows the user to toggle the contrast with '1' being the lightest and '9' being the darkest. The screen will reflect the change when either a number is pressed or the selection is highlighted and the "Enter" key is pressed. To exit the screen press "0" or a softkey.
- 5) **Select video color scheme:** Choose from two visual color schemes, either white letters on a black background or black letters on a white background. Either selection will have no effect on the performance of the unit.
- 6) **Setup menu:** Saves changes and returns to setup menu.

## SERIAL PORT MENU

The analyzer contains two serial interface input/outputs to handle most interface requirements.

A 9-pin "D" type connector (digital I/O) provides a standard pin configuration for a serial RS232 output with no hardware handshaking.

- eight data bits
- no parity
- one stop bit

All cables used should be in this pin configuration:

Pin Call Out	Function
1	case ground
2	serial data in
3	serial data out
4	CTS (Clear to send)
5	RTS (Request to send)
6	no connection
7	signal ground
8	no connection
9	no connection

- **25 pin:** This output port supports a bi-directional RS232 interface via a 25 pin, DB-25P type connector for intercommunication between two moisture analyzers for the purpose of transferring drying procedures through the “transmit all procedures” subroutine, outputting of results or remote command entry.
- **9 pin:** This output port supports a uni-directional RS232 interface via a 9 pin, DE-9S type connector. Any RS232 compatible device such as an external printer or computer can be connected to the analyzer to receive (only) result data output. This serial connection also supports bar code scanning devices

If an external device, such as a printer or computer, is connected the device will receive data in the same format as the internal printer setup.

See Appendix E for further information on communication commands.



A warning message will appear on the display (when a test is initiated), if the either of the serial ports are turned ON and the external devices are not connected (i.e. no cable plugged in).

- 1/4) Turn port on/off:** Turn port on when attached to an external device.
- 2/5) Select baud rate:** Various baud rates can be selected for either serial port (150, 300, 600, 1200, 2400, 4800,9600). Make sure that if a printer or computer is attached to the analyzer that the baud rates of both are identical.
- 3/6) Setup serial port:** Select the data bits, parity and stop bits for the serial port. Also turn the count on or off. Make sure that if a printer or computer is attached to the analyzer that the parity, and cts. are identical.
- 7) Printer:** Turn port on/off: When this is off the internal printer will not print
- 8) Transmit all procedures:** When you connect two *μWaves* with the transfer cable, this feature will send all programs with settings to the other *μWave*.
- 9) SETUP MENU:** Saves all changes and returns to Setup menu.

## SECURITY MENU

The Security subroutine of the analyzer prohibits unauthorized entry of selectable routines and subroutines.

- 1) Print analyzer info:** Will send *μWave* version of code and serial number to printer.
- 2) Set password on/off:** If password is turned ON, a password must be entered to access any menu beyond the main menu. If the password is not entered correctly, then the operator will be denied entry to the secured routines. When password is turned OFF, all analyzer routines and subroutines can be accessed without entering a password.
- 3) Set password:** Select to change the current password to a new password.
- 4) Use standard printout:** Resets all printer options to factory default.
- 5) Clear data log:** Clears all points in the data log
- 6) Clear operators:** Clears all operators
- 7) Clear procedures:** Clears all programs including factory defaults.
- 8) Load default procedures:** Restores all factory default procedures listed in this manual.
- 9) Restore all defaults:** This is a factory reset that erases all custom settings (including programs, operators, printer settings, serial port settings, security settings and clears the data log)

## SERVICE MENU

This area is reserved for troubleshooting and repair work. If you feel that you need access to this menu contact Omnimark Instrument Corporation for the password and for technical support.

# Applications

---

It may be necessary to optimize drying procedure for accurate and consistent results if a default procedure does not work for your application. Although the microwave technology is based on the presence of water within a sample, some samples need to have a comparison or reference value to optimize the procedure on the ***μWave***. Once a procedure has been optimized the user can comfortably test the sample with relative ease and accuracy without having to use a standard method.

There are several areas to concern yourself with when developing a procedure.

**1. Preparation of sample:** For many samples no preparation is required while others need some sort of prep work to ensure an even and consistent sample. Consider the following for your application:

- Homogenizing: In many cases this is simply stirring the sample prior to placement on sample pads. The reason for this is to get a good representation of the sample's moisture content.
- Grinding: Some samples might, by size or matrix, hold moisture in the center of the sample. To provide quick and reproducible results, grinding the sample allows for even moisture analysis of the sample.
- "Sandwiching": A term used for the use of two quartz pads to 'sandwich' the sample. This procedure is commonly used because it helps in several applications. Make sure that if two quartz pads are being used that both are placed on the pan support when the balance is zeroed out.
  - Samples containing fat may be subject to splattering which in turn results in unwanted weight loss of the sample. By adding a second pad on top of the sample, this splattering is contained between the pads.
  - Samples that do not readily absorb microwave energy also benefit from this method. The two pads help retain heat which aids the liberation of moisture.
  - Materials with a "doughy" consistency will dry more evenly if pressed thin and flat. The two pads will provide an intermediate barrier when pressing the sample.

**2. Sample size:** Sample size for each sample should be consistent and in most cases a sample size from 0.5 grams to 3.5 grams is ideal. Data can only be as consistent as each test run, thus being consistent in the test procedure will help in the consistency of the data.

**3. Power Setting:** Power level selection is the most important criteria within your application development strategy. When selecting the power level for your material, you must consider the basic components of the material. Samples that contain materials with high dielectric strengths (such as sugar) should be analyzed at lower power settings. However, most samples run at 100% power. When the analysis is complete check for any burning of the sample. If the sample's integrity is not upheld reduce the power in 20% increments until sample is no longer burned. The higher the power the faster the analysis time.



If at any time smoke is visible in the exhaust of the fans, stop the test immediately, and place the sample in water to prevent smoldering.

**4. Slope Variables:** There are two slope variables to consider. The first is the slope time. This is the length of time that the unit runs before it looks at the second variable of slope end. These two features are often adjusted together. A good place to start is with the slope time at 5 and the slope end at 2 (5/2). After running the sample feel the pad. If the pad is still wet or if a higher % moisture is expected, increase the settings to 10/1. If the % moisture is still too low try the tightest endpoint of 15/0. On the other hand if the sample looks like it has been “over cooked” or the % moisture value is too high it may be necessary to loosen the endpoint to 3/5. If at any stage if you are able to get one moisture value too high at one setting and too low at another setting, adjust the slope time and slope end until the perfect criteria is met.

**5. Step (Time 1, Power 2):** For some samples it is necessary to set a step in the program. Indications that a step is needed are that the total analysis time is under thirty seconds or that it runs for different lengths of time giving different results. If the sample is not running long enough, also indicated by low moisture reading, increase time 1 to 30 seconds. Continue to increase time 1 until satisfactory times are being ran (typically not over 150 seconds). Sometimes it is necessary to run a sample at a higher power for a set amount of time and then lower the power to carry it to the endpoint. This is also a step procedure. Set the time 1 to be the amount of time to run at power 1 and then adjust power 2 to be the power to be ran until the endpoint condition is met.

**6. Custom Units:** This feature allows scale (factor) and/or bias (offset) correction to the final result. It may be necessary to use this feature for the following reasons:

- Some samples may have components (such as volatiles) that are not effected similarly to the current method.
- A current method does not match up with the ***μWave*** result.
- Samples have cooled before testing began.

If this is the case, an offset can be entered to compensate for these characteristics. From there it is possible to use a multiplication factor or add/subtract an offset. If the result is always off by a certain percentage (i.e. the result on the ***μWave*** is 45% and the reference is 57% and a sample at 32% on the ***μWave*** is expected to be 44%) a custom offset can be entered (in example, 12%) so the results are in range. If the results are always off by a ratio (i.e. the result on the ***μWave*** is 45% and the reference is 57% and a sample at 32% on the ***μWave*** is expected to be 41%) a custom scale can be entered (in example, 1.3). When a custom unit is entered, there is no need for any other calculations not will a bias entry screen appear during test mode. Weight data will not be altered and will not show the bias.

**7. Sample Disposal:** Dispose of all samples in accordance to local regulations. Contact local authorities if unsure of how to properly dispose of post-test materials.

## Appendix A — Recommended Care

---

The ***μWave*** moisture analyzer is an integrated system designed to provide precise, fast determination of moisture content. Therefore, proper care and routine maintenance of the unit is required to prevent accidents, to ensure reliable results, and to avoid damage to the unit.

### **Before beginning the cleaning process:**

- Unplug the unit.
- Allow the unit to cool down for a period of 30 minutes.
- Use a mild detergent and a soft rag to clean the external surfaces of the unit.
- Do NOT immerse the unit in water or any other cleaning solution.

### **Your daily regiment should include the following:**

- Carefully remove pan stem and thoroughly clean with a mild detergent. Dry completely before reinstalling.
- Wipe clean the inner chamber bottom and top, as well as the cover and work area.

## Appendix B — Printer Paper Installation

---

Installation of thermal printer paper using Omnimark Instrument part number 901121.1 is as follows:

- Locate printer module arm on the right side and pull arm towards the front of the unit. It may be necessary to slightly close the printer cover to fully extend the arm.
- Insert a clean edge of the new roll into the paper feed slot located on the rear of the printer module.
- As soon as the paper entering the module is sensed the printer will auto-feed the paper. Then simply reset the printer arm, feed the paper through the slot in the cover, and close cover.



The thermal paper can only print on one side of the paper.



## Appendix C — Maintenance

---



### Warning!

**This unit does not contain any user serviceable parts.  
For technical assistance and repair contact  
OMNIMARK INSTRUMENT CORPORATION at 1-800-835-3211.**

Be sure to keep the inner chamber surface clean at all times. Ensure that there is no debris from past samples in the bottom of the chamber cavity. Periodically calibrate the balance to ensure accurate results.

## Appendix D — Trouble Shooting

---

---

<b>Results too low</b>	Loosen slope settings and/or raise power level.
<b>Results too high</b>	Tighten slope settings and/or lower power level.
<b>Inconsistent results</b>	Use a consistent and appropriate sample size. Optimize drying procedure by adjusting power and slope settings. Calibrate balance. Ensure that the platform that the unit is on is level and free of vibrations.
<b>Will not start a test</b>	Make sure that the latch on the hood is completely closed. Power setting may be set at zero. Low or no voltage from line.
<b>Printer will not print</b>	Internal printer not turned on. From main screen select #5 Options menu, then # 7 Serial port, and finally verify that #7 Internal printer is turned on. If the printer head moves but does not print, make sure that the paper had been installed properly as the printer can only print on one side of the paper.

---

## Appendix E — Serial Communication Commands

---

Serial commands are case-insensitive (i.e. they are converted to uppercase on receipt). All characters are ASCII, not ANSI, so use 'Terminal' font in Windows to see special characters correctly (i.e. degrees, accents, Greek symbols).

("Normal" letters and numbers are coded the same in both sets.)

The following commands are supported:

```
SET TIMESTAMP #timestamp#
(GET) TIMESTAMP
    sets date and time using the number of seconds since 1/1/1970
SET DATETIME dd/mm/yyyy hh:mm:ss
(GET) DATETIME
    sets date and time using formatted strings
    (24 hour format, leading '0's required)
(GET) SCALE
    show a reading
(GET) INFO
    print analyzer info (software version and serial #)
(DO) DISPLAY $display_string$
    display text on top line
(DO) DISPXY #Xpixel# #Ypixel# $display_string$
    display text at given location
(DO) KEYS $keys$
    enter one or several keystrokes
```

Where:

{ } = choice of required parameter

( ) = optional parameter

#timestamp# = # of secs since 1/1/1970

\$display\_string\$ = ASCII string (not ANSI)

#Xpixel# = {0-239} (0=top line)

#Ypixel# = {0-239} (0=top line)

\$keys\$ = one or several of {0123456789.-ELRUDTN!@#}\$

E = Scientific notation

L = Left arrow key

R = Right arrow key

U = Up arrow key

D = Down arrow key

T = Start key

N = Enter key

! = (Shift-1) = Softkey 1 (Left softkey)

@ = (Shift-2) = Softkey 2

# = (Shift-3) = Softkey 3

\$ = (Shift-4) = Softkey 4 (Right softkey)

## Appendix F — Accessories

---

Part No.	Description
0-2004	4" Glass quartz pads. Pkg. of 400
0-2086	4" hi-grade glass quartz pads. Pkg. of 400
0-2061	Printer Paper. Pkg. of 10 rolls
0-2114	µWave Operation Manual
0-2112	Calibration Weight 10gm class 2
0-2166	Carrying Case with wheels (26x26x17)

## Appendix G — Factory Default Drying Procedures

---

### 1. Default Procedure

Power 1: 100%  
Time 1 : 0 sec  
Power 2: 100%  
Slope time: 5 sec  
Slope end : 2 ppt.

### 2. Standard (Water)

Power 1: 100%  
Time 1 : 25 sec.  
Power 2 : 100%  
Slope time: 5 sec  
Slope end : 2 ppt.

### 3. Cheese, Sliced

Power 1: 70%  
Time 1 : 0 sec  
Power 2 : 70%  
Slope time: 10 sec  
Slope end : 1 ppt.

### 4. Milk, Whole

Power 1: 100%  
Time 1 : 0 sec  
Power 2: 100 %  
Slope time: 5 sec  
Slope end : 1 ppt.

### 5. Yogurt, Low Fat

Power 1: 90%  
Time 1 : 0 sec  
Power 2 : 90%  
Slope time: 5 sec  
Slope end : 2 ppt.

### 6. Meat, Potted

Power 1: 100%  
Time 1 : 0 sec.  
Power 2 : 100%  
Slope time: 4 sec  
Slope end : 3 ppt.

### 7. Tomato Paste

Power 1 : 80%  
Time 1 : 0 sec  
Power 2 : 80%  
Slope time: 9 sec  
Slope end : 4 ppt.

### 8. Beef, Ground

Power 1 : 90%  
Time 1: 0 sec  
Power 2: 90%  
Slope time: 5 sec  
Slope end: 2 ppt

### 9. Butter

Power 1 : 90%  
Time 1: 0 sec  
Power 2: 90%  
Slope time: 8 sec  
Slope end: 2 ppt

### 10. Latex

Power 1 : 100%  
Time 1: 0 sec  
Power 2: 100%  
Slope time: 15 sec  
Slope end: 1 ppt



## Warranty Instructions

---

1. Please return the prepaid, pre-addressed Purchase Registration Card to Omnimark Instrument Corporation promptly upon your purchase of the Omnimark product. the return of the card is not a condition precedent to warranty coverage.
2. If it becomes necessary to return your Omnimark Instrument Corporation product for service, you must obtain a **"Return Authorization Number"**. Please pack the product securely in its original approved packing carton or other suitable container and include your Return Authorization Number on the shipping label and as a precaution also a note inside the box. Shipping charges must be fully prepaid.

In the U.S. ship to:

**Omnimark Instrument Corporation  
1320 South Priest Drive, Suite 104  
Tempe, Arizona 85281**

**Telephone (USA) 800-835-3211  
Telephone (outside USA) 480-784-2200  
Fax: 480-784-4738**

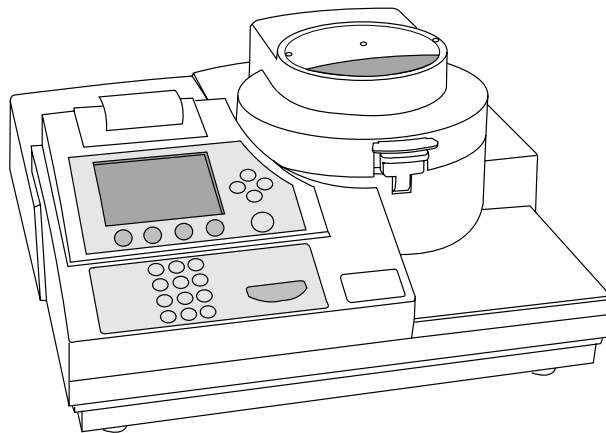

OMNIMARK



INSTRUMENT CORPORATION

The logo consists of a stylized globe showing the continents of North and South America, enclosed within an oval frame. A horizontal line passes through the center of the globe.

Omnimark Instrument Corporation  
1320 South Priest Drive, Suite 104  
Tempe, Arizona 85281

Telephone (USA) 800-835-3211  
Telephone (outside USA) 480-784-2200  
Fax: 480-784-4738